

Datasheet for HHL-33

Recommendations:

Please read the starter kit user manual, if available, and have a look at the FAQ at <http://www.alpeslasers.ch/alfaqa.pdf>

WARNING: Operating the laser with higher current or voltage than specified in this document may cause damage and will result in loss of warranty, unless Alpes Lasers has permitted to do so!

WARNING: Beware on the polarity of the laser. This laser has to be powered with negative pole on the pin 7 and positive pole on the pin 4. To use with a power-supply ILX Lightwave LDX-3232 or equivalent.

WARNING: Avoid bending module by applying too much torque on mounting screws. Keep temperature change rates below 10 degrees per minute.

MODULE PIN-OUT	Pin n°
TEC (-)	1
Nonexistent	2
Not connected	3
Positive contact of the laser	4
Temperature sensor	5
Temperature sensor	6
Negative contact of the laser	7
Not connected	8
Not connected	9
TEC (+)	10

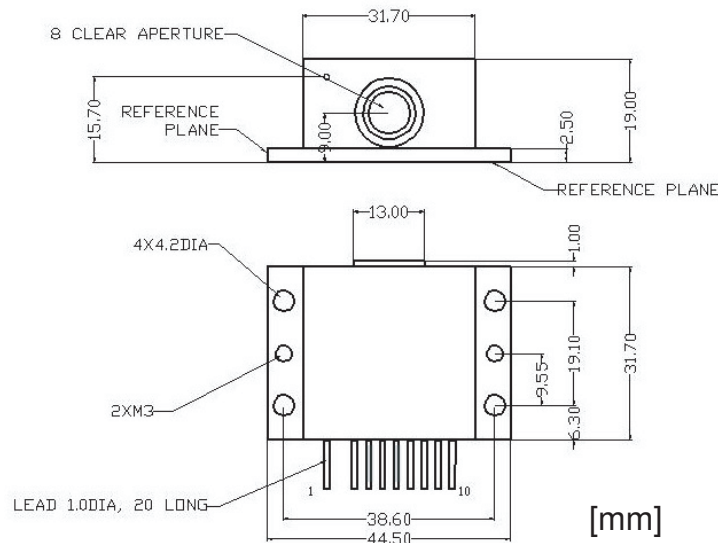

Figure 1: Support mounting for HHL-33 (specifications of the HHL-L module)

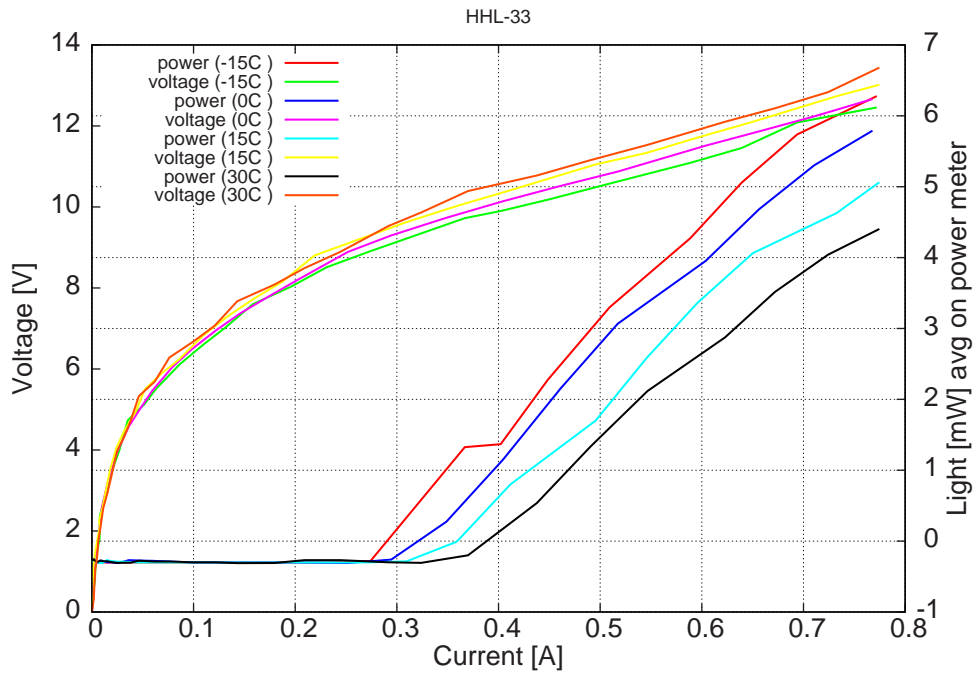

Figure 2: peak voltage and average power vs peak current at 2% duty-cycle (100ns pulses on the laser, $5\mu\text{s}$ period)

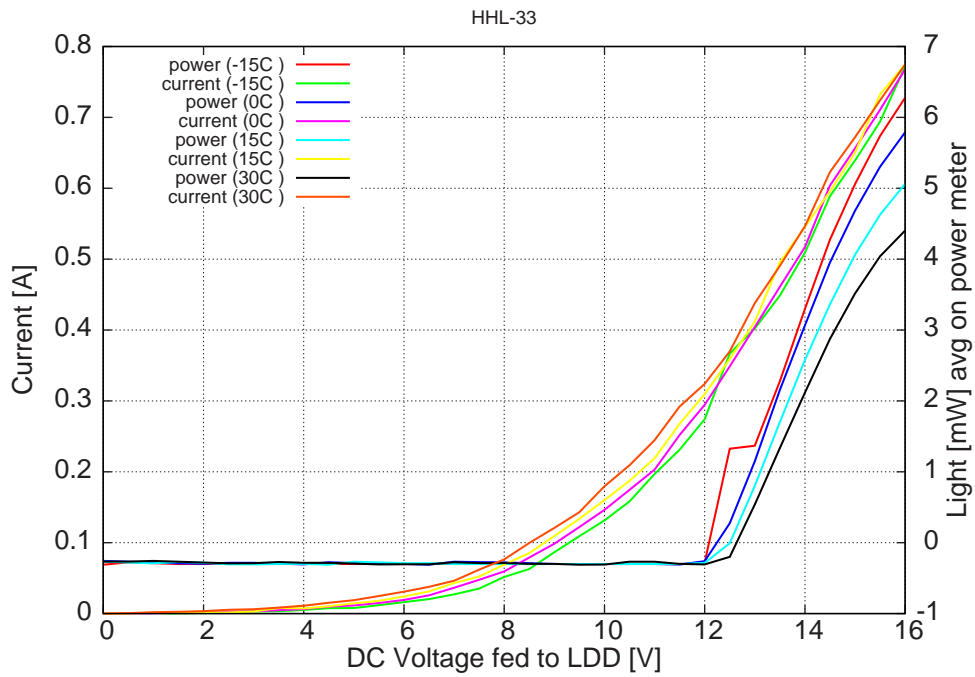
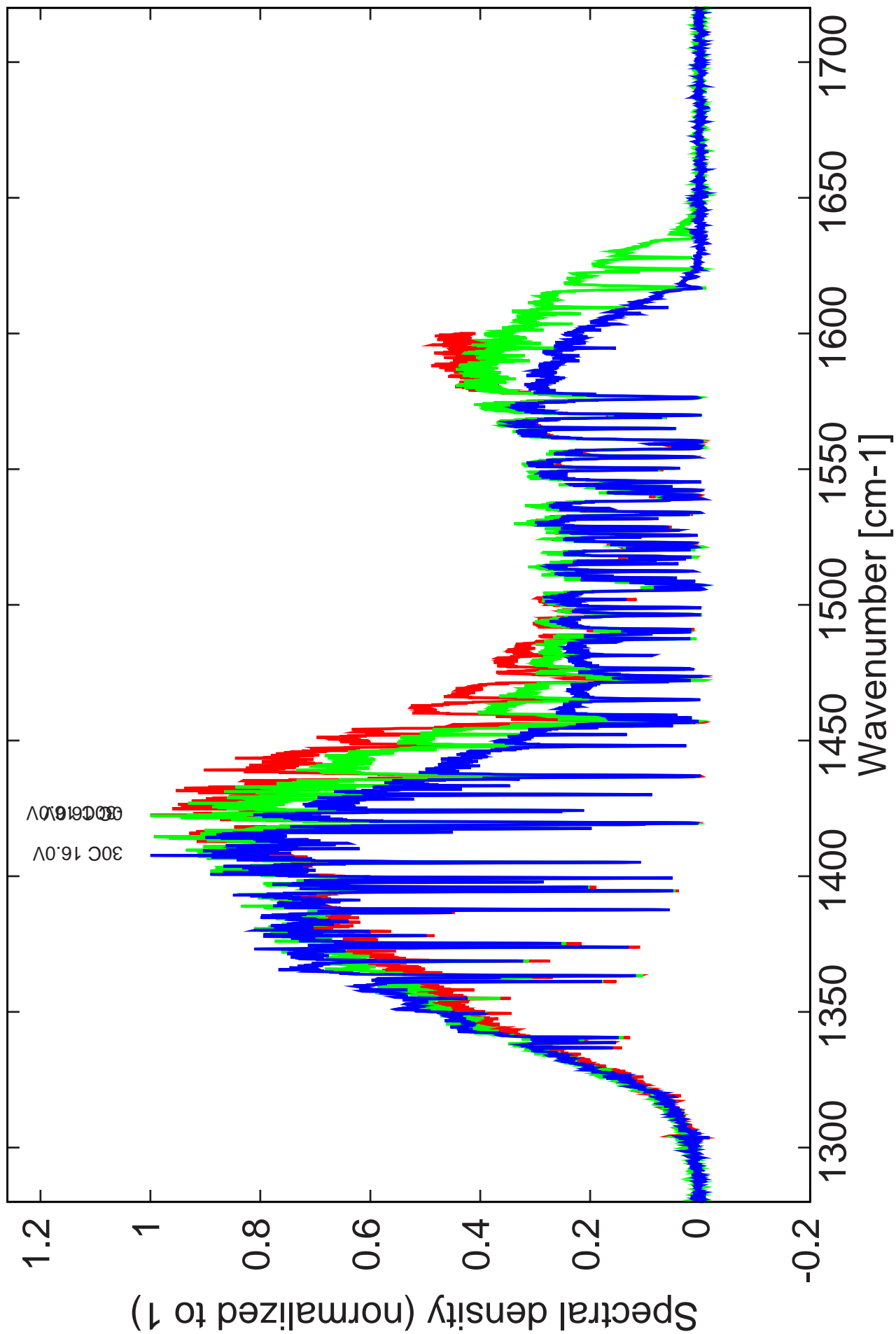

Figure 3: peak current and average power vs LDD voltage at 2% duty-cycle (100ns pulses on the laser, $5\mu\text{s}$ period)

Figure 4: spectra at 2% duty-cycle (100ns pulses on the laser, 5us period)



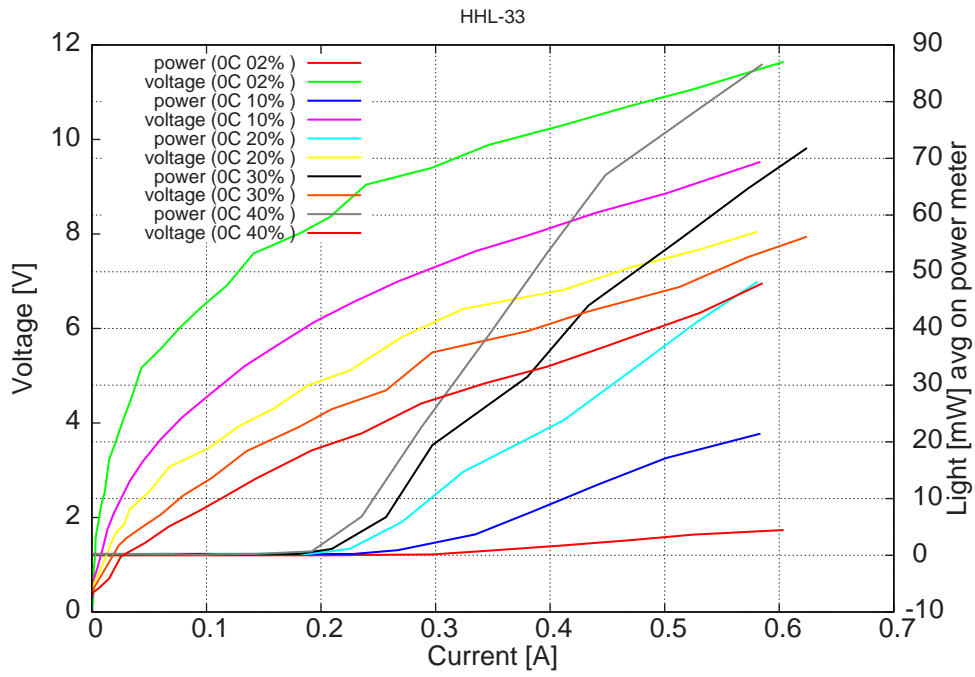

Figure 4: peak voltage and average power vs peak current at 0C for various duty-cycles (100ns pulses on the laser)

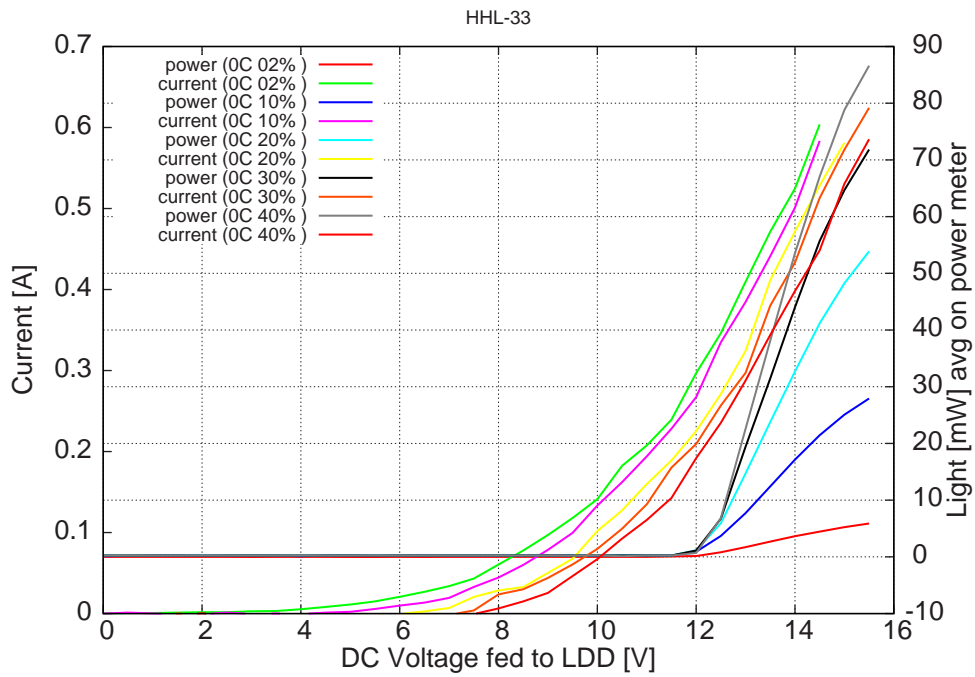

Figure 5: peak current and average power vs LDD voltage at 0C for various duty-cycles (100ns pulses on the laser)

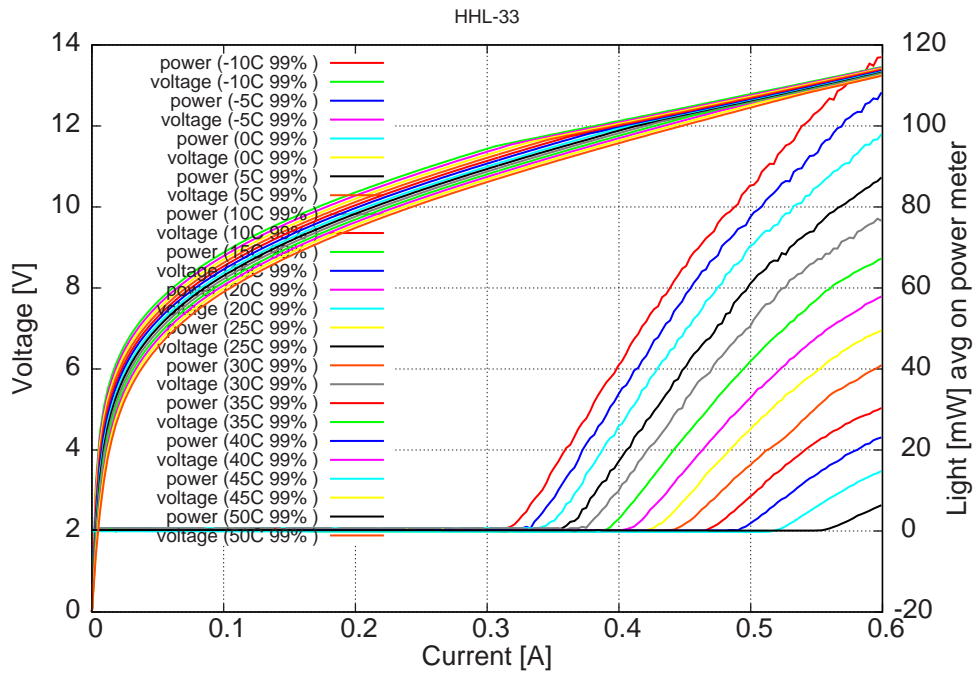

Figure 6: voltage and avg power vs current in continuous-wave operation

Note: at -10C: $I_{th}=315\text{mA}$ / $V_{th}= 11.6\text{V}$ (2-wires measurements). Maximum operation current: 0.60A for all temperatures.

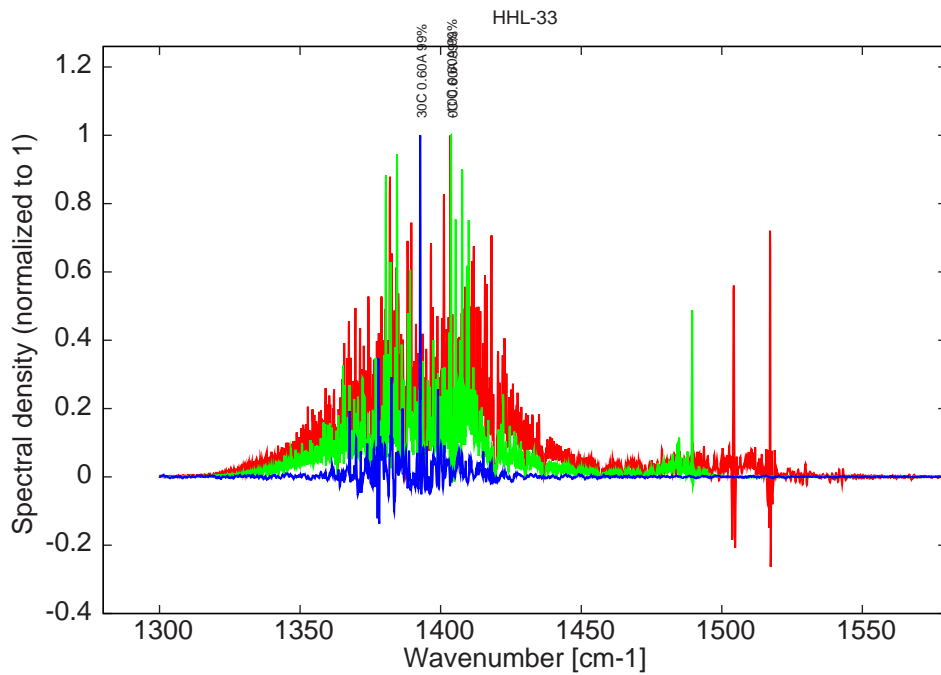

Figure 7: spectra at different temperatures in continuous-wave operation